

PHILIPS

hue personal
wireless
lighting

Enrave



HUE serial number



User manual
Benutzerhandbuch
Notice d'emploi
Manual de usuario
Manual do usuário
Manuale d'uso

Enrave

Incl.

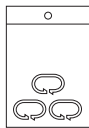
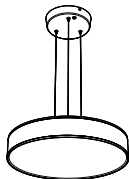

1 x CR2032 +

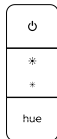

Excl.

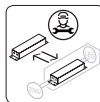
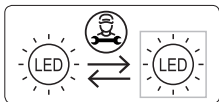
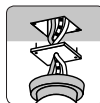
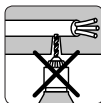
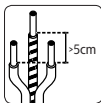
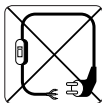
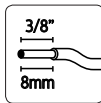
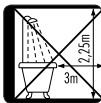
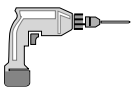

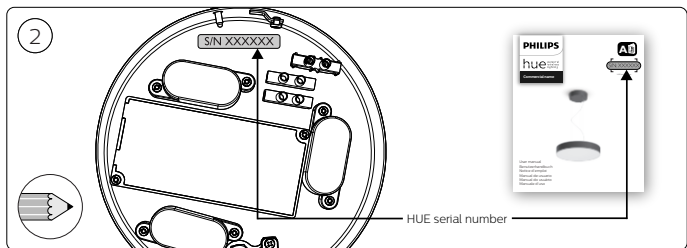
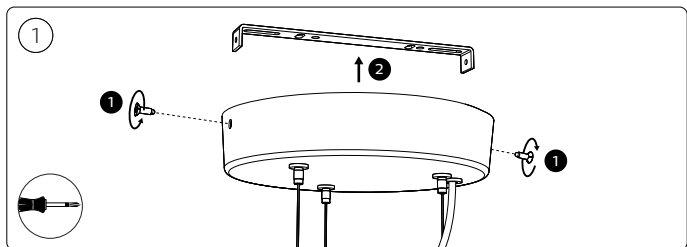
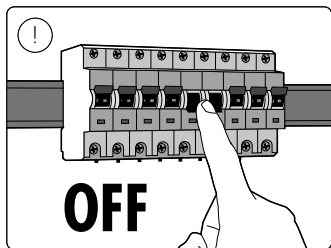

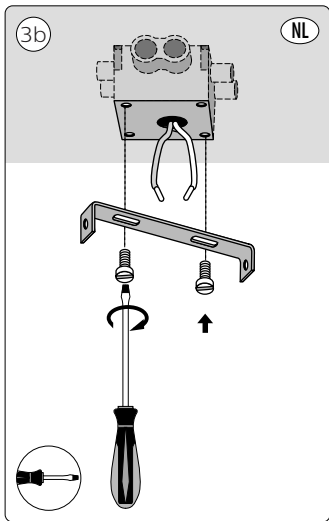
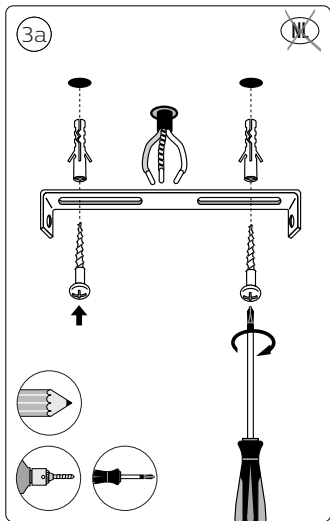

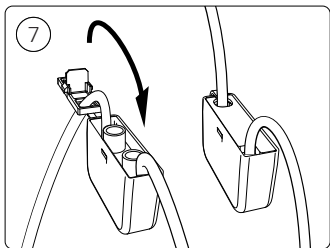
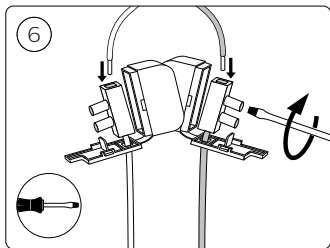
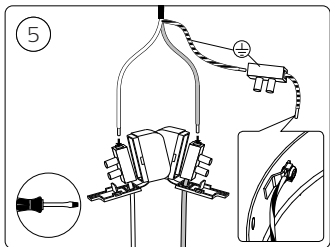
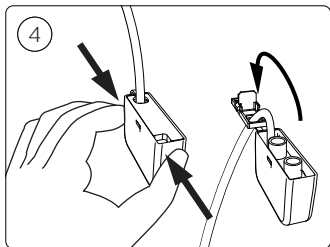

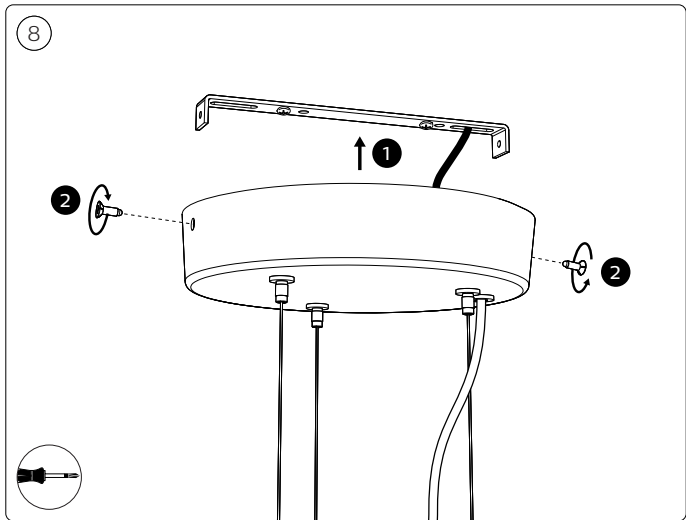

9

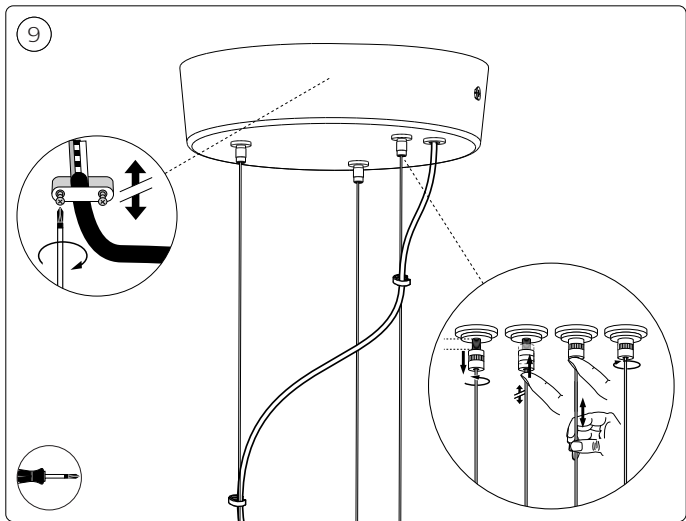

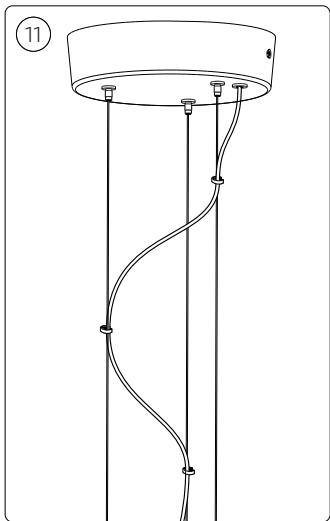
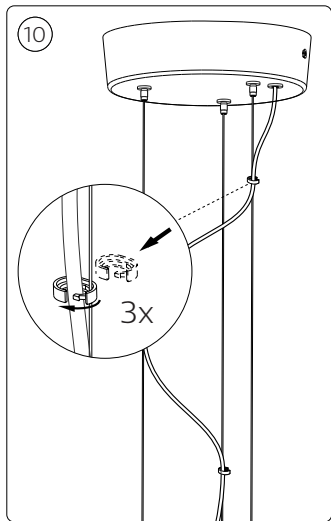

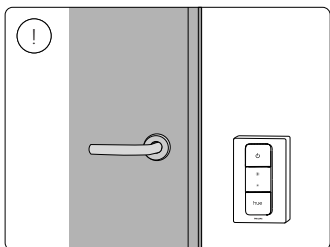
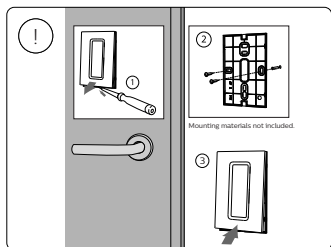
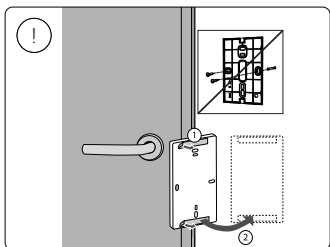
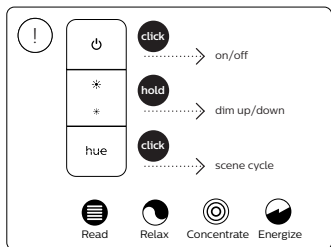
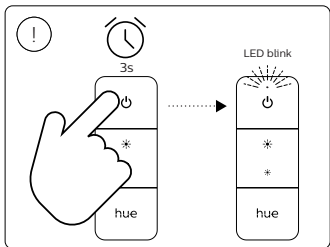
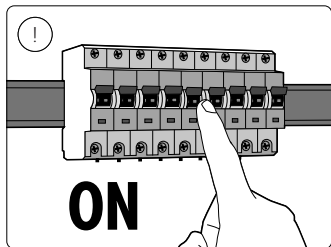

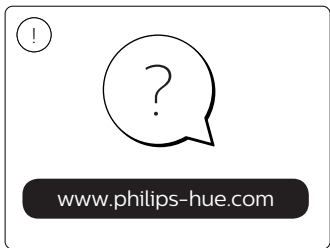
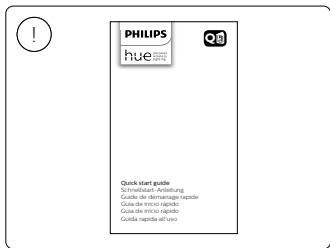
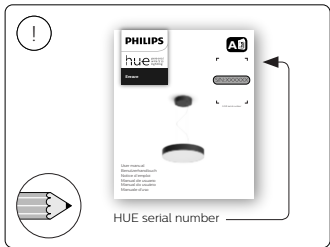
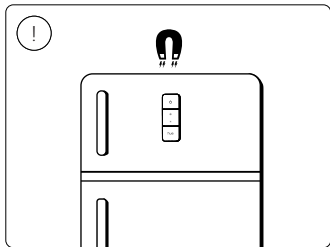



Signify
I.B.R.S. / C.C.R.I. Numéro 10461
5600 VB Eindhoven,
the Netherlands
☎00800-74454775

© 2021 Signify Holding
All rights reserved

www.philips-hue.com

4422 954 80381
Last update: 03/2021